

MAP - Mobile Application Part

Mobility Management in GSM
GSM services

Short Message Service

CAMEL = IN+GSM integration

Course scope - lecture scope

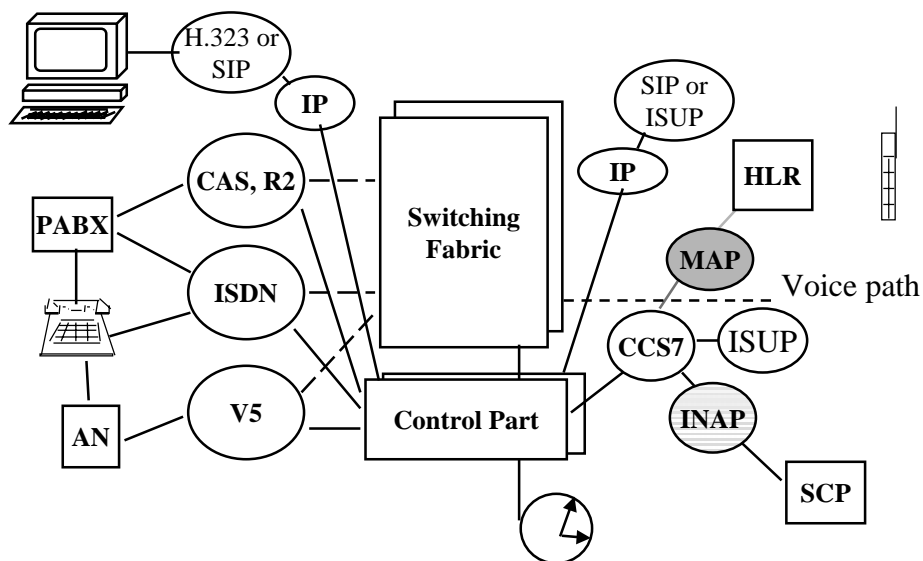

GSM system consists of 4 sub-systems

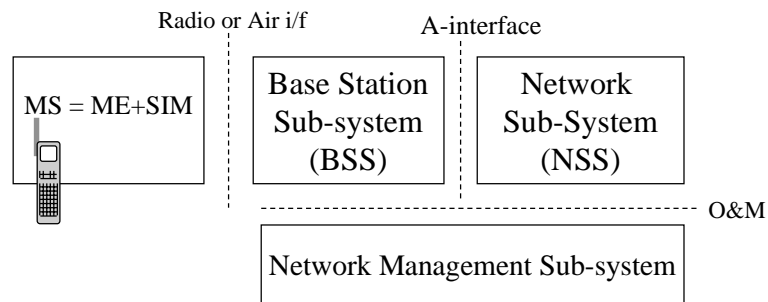

MS - Mobile Station
 ME - Mobile Equipment
 SIM - Subscriber Identity Module
 BSS - Base Station Subsystem
 NSS - Network Sub-System

Main differences cmp to wire-line networks
 - air interface for the subscribers
 - mobility and roaming of users
 NB: the whole system is digital incl the ME.

NSS interfaces are

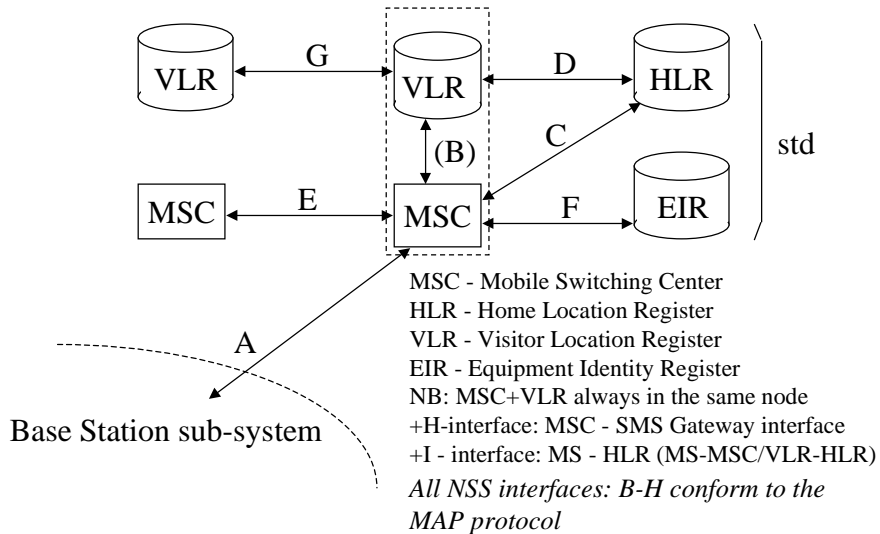

Milestones in MAP development

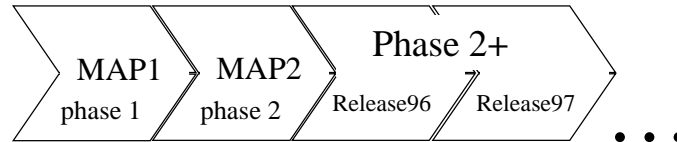

- In phase 2+ versioning is per operation package.
- This supports the idea of deploying small sets of features at a time in the network.
- If the remote systems does not understand the newest tricks, *fall-back negotiation* restores operation on the level of the previous version.

MAP -operations can be mapped to interfaces

I/F	Elements	Mobility management	O&M	Call handling	Supplementary services	Short messages	Sum
B	MSC - VLR	12	1	4	1	2	20
C	GMSC - HLR			1			1
D	VLR - HLR	9	3	1	10	1	24
E	MSC - MSC	5					5
F	MSC - EIR	1					1
G	VLR - VLR	1				1	2
	HLR - SMSGW					3	3
	MSC - SMSGW					1	1
Sum		28	4	6	11	8	57

The table corresponds to MAPv2

This lecture does not discuss MSC-VLR interface operations nor O&M -operations.

Addressing MAP messages

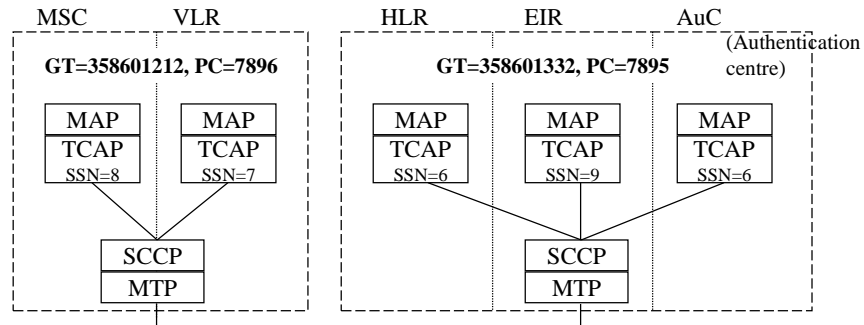

GT formats:

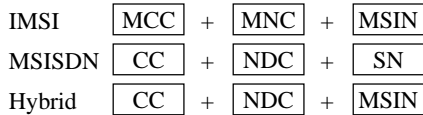

GT - Global Title
 PC - Point Code
 MCC - Mobile Country Code
 CC - Country Code
 MNC - Mobile Network Code
 NDC - National Destination Code
 MSIN - Mobile Subscriber Identity Number
 SN - Subscriber Number

MAP uses the structured dialogue provided by TCAP

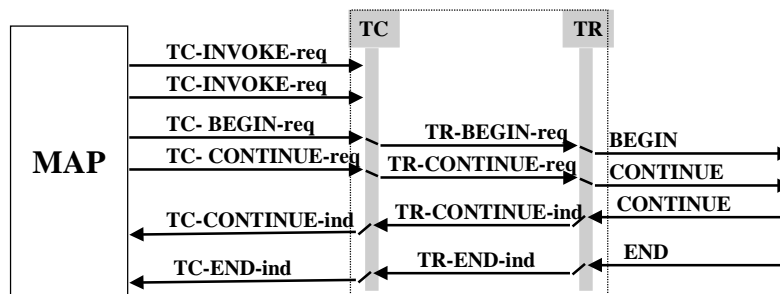

- Begin causes a *transaction identifier* to be reserved.
- The remote system can either continue the transaction or close it.
- Continue - messages are exchanged in a full-duplex mode.
- Closing options:
 - based on pre-arrangement independently
 - normally by the End-message or “abnormally” by an Abort message

Mobility management is the most important feature in MAP

- Location management
- Handover MSC-MSC during a call
 - handover is supported on many levels - also BSSAP (A- i/f protocol) is needed, but we do not cover that here
- Authentication and security
- IMEI - mobile equipment id queries
- Subscriber management
- Fault recovery

Home Location Register - HLR - contains subscriber and service information

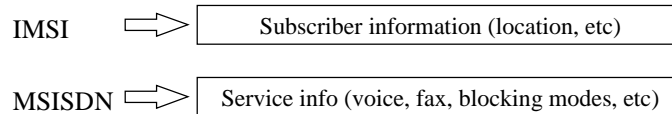

In a mobile terminated call, the right HLR can be found based on a *prefix in MSISDN* or if *free numbering within the operator network* is supported, a Global Title (MSISDN is embedded in the GT in SCCP) translation needs to be done first e.g. in a specific network element.

Location management maintains the location of the MSs in the HLR

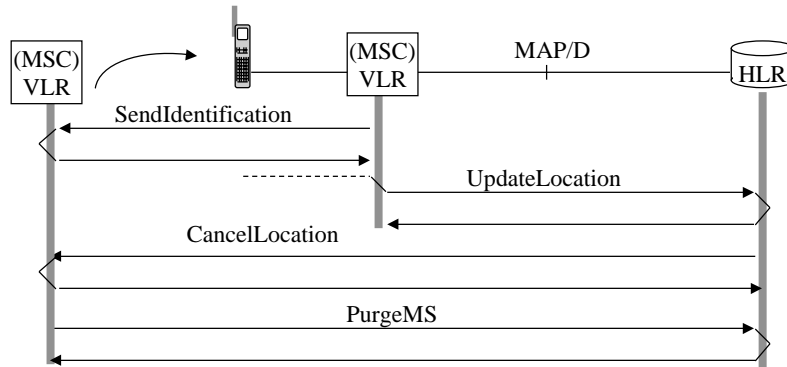

- **SendIdentification** requests MS info (IMSI, authentication) from the previous VLR.
- **UpdateLocation** updates the new location with the accuracy of a VLR area
- **With PurgeMS** VLR tells to HLR that MS is unreachable.

With HLR query the MS is found in a Mobile terminated call

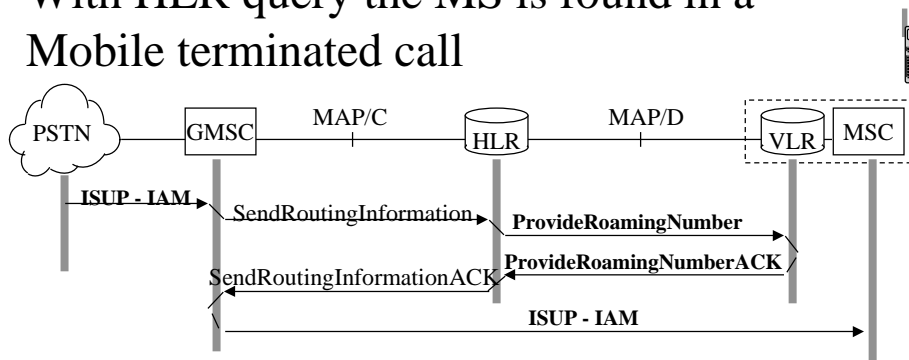

MSRN - Mobile Subscriber Roaming Number

- conforms to E.164 format (any exchange can pass along the number)
- each MSC has a limited range of MSRNs
- MSRN has a validity timeout
- MSRN may be allocated on a call by call basis or for the duration of the visit

Handover from MSC to MSC

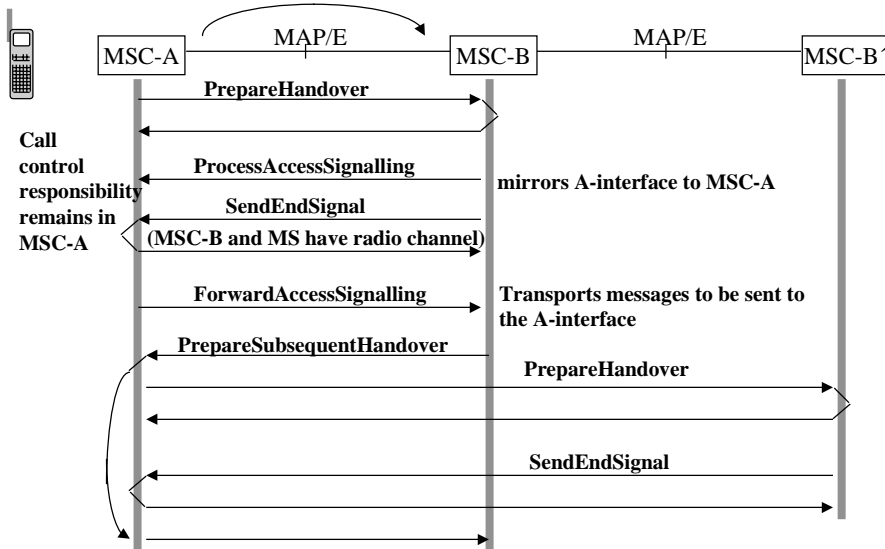

Security operations ensure that only authorized subscribers can use the service

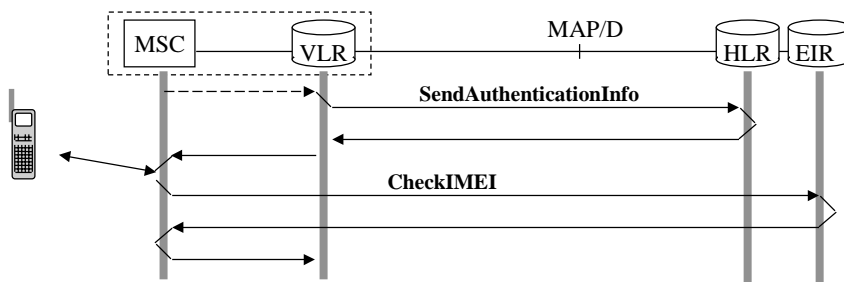

Black list of suspect stolen phones ensures that stolen equipment can not be used for long

Subscriber management takes care of the subscriber data

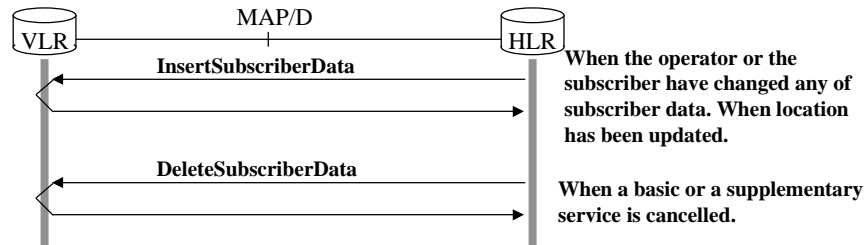

When the operator or the subscriber have changed any of subscriber data. When location has been updated.

When a basic or a supplementary service is cancelled.

With these operations all information residing in the VLR, can be manipulated, when the HLR has the master copy of the information. (HLR does not have some detailed location info...)

Supplementary service operations are passed from MS via MSC/VLR to HLR

MS --> MSC/VLR --> HLR

RegisterSS	Activation of call forwarding
EraseSS	Switching off supplementary services
ActivateSS	Activation of call blocking
DeactivateSS	Deactivation of supplementary services
InterrogateSS	Interrogation of supplementary service settings
RegisterPassword	Password setting for SS
GetPassword	Password query to MS
USSD operations	Unstructured SS data transport

USSD - Unstructured Supplementary Service Data transports SS data between MS and the network

- Network destinations can be e.g.
 - MSC, VLR, HLR
 - HLR-> SCP, WWW-server
- Data is in “ascii”(cmp DTMF)
- E.g. WAP - Wireless Application Protocol can in principle use the USSD service
- a latecomer among features

USSD uses the structured dialogue of TCAP

- Dialogue is connection oriented
- A Dialogue has an identity
- Are independent of calls
- Message length is 80 octets, having max 91 Ascii characters a´ 7-bits



USSD dialogue can be initiated by MS (pull) or by a server (push)

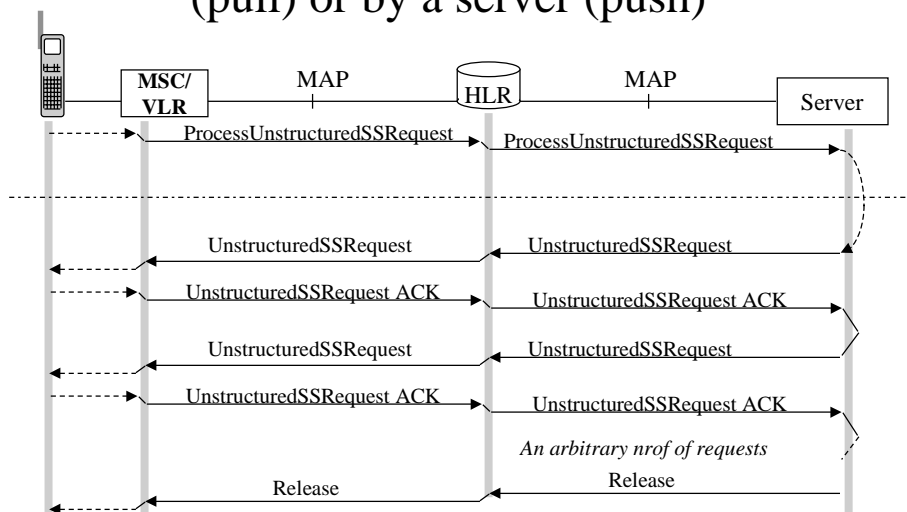

Raimo Kantola/ k2001

Telecommunications Switching Technology I

17 - 19

Short Message Service

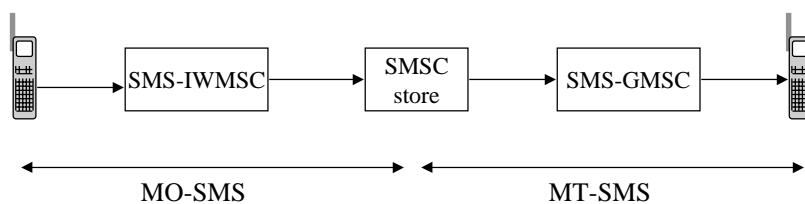

SMSC - Short Message Service Center (or SC - Service Center)
 SMS-GMSC - Short message Gateway MSC, issuer of routing information query to HLR in MT-SMS
 SMS-IWMSC - Short message Inter-working MSC, routing MSC in MO-SMS service
 SMS-GW = SMS-IWMSC + SMS-GMSC

MO - Mobile Originated
 MT - Mobile Terminated

SMSC - HLR operations:
 - MS short message buffer full
 - MS reachability
 - successful delivery of message

Raimo Kantola/ k2001

Telecommunications Switching Technology I

17 - 20

Short message transport protocol stack

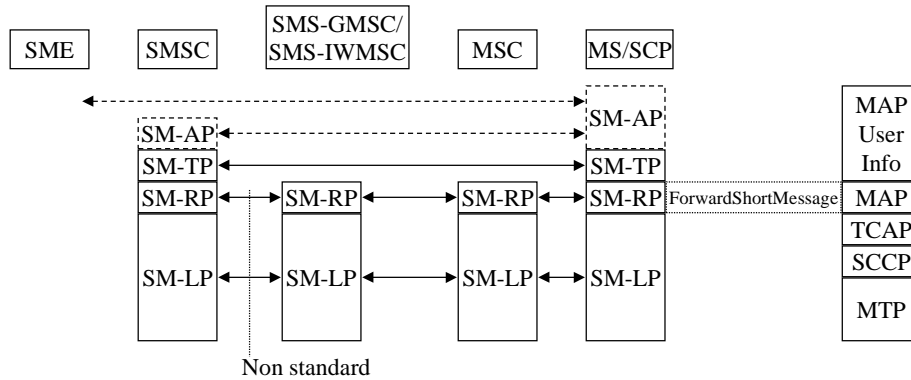

SME - Short Message Entity
 SM-LP - Short Message Link Protocol
 SM-RP - Short Message Relay Protocol
 SM-TP - Short Message Transfer Protocol
 SM-AP - Short Message Application Protocol

Messages in MO-SMS service

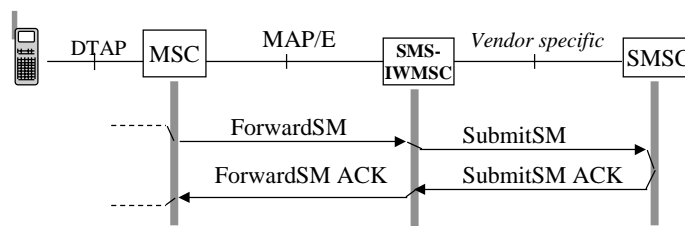

Messages in MT-SMS service

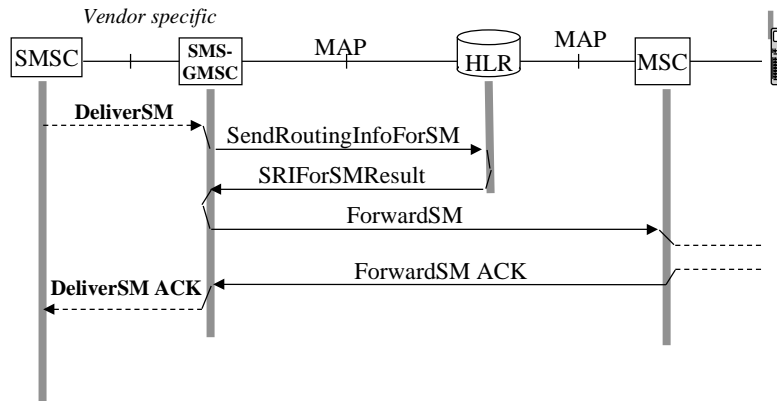

Status information is kept in HLR

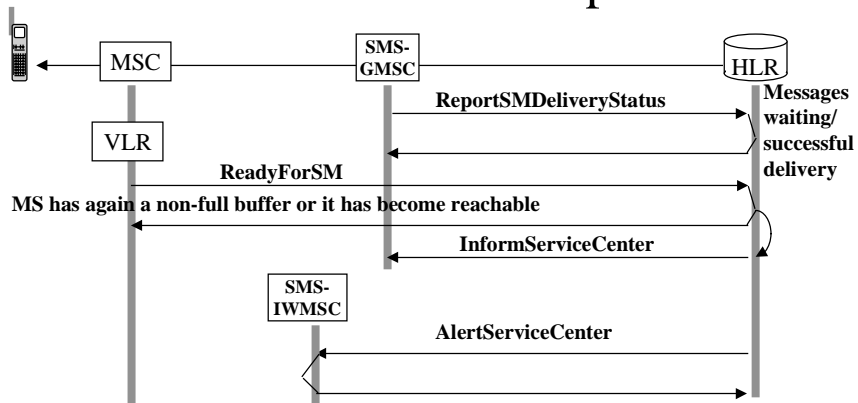

- SM destination subscriber can tell the network, that its SM buffer is full or that the subscriber has become unreachable. HLR stores the status.
- When Status is good for receiving, VLR gets the info and sends it to HLR.
- HLR informs those SMSCs that have reported themselves onto the waiting list.

Addressing of Short messages

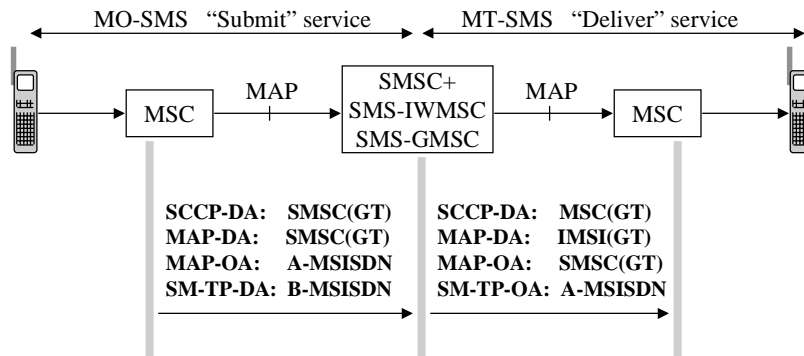

SMSC gets the IMSI of the B subscriber and the address of the VMSC by SRIForSM operation from the HLR.

NB: Addresses are on three protocol layers!

CAMEL adapts the IN technology to GSM

- CAMEL - Customized Application for Mobile network Enhanced Logic
- The goal is the capability of providing the home network services to visiting subscribers
- CAP - CAMEL Application Part is a subset of ETSI CoreINAP
 - phases (Capability Sets) 1 and 2 are ready

IN is a way of implementing services in nodes separate from exchanges

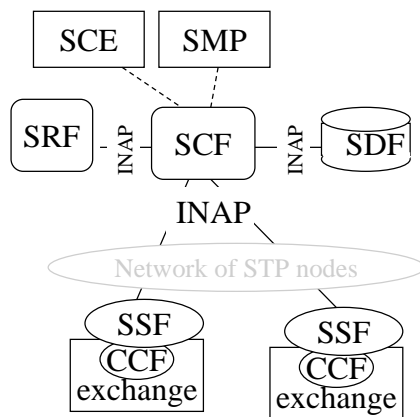

INAP = IN Application Part
= main protocol

SSF - Service Switching Function
maintains call state with CCF

SCF - Service Control Function
implements service logic

SRF - Special Resource Function
processes in-band signals

SDF - Service Data Function
is a database

SCE - Service Creation Environment
for creating new service logic

SMP - Service Management Point
implements mgt functions

Features of the IN architecture ...

- BCSM - Basic Call State Model is a standardized state machine in SSP - couples/ de-couples IN service logic from connection resources
- BCSM states (detection points) can be programmed to trigger on conditions queries to an SCF concerning a certain call
- BCSM architectural issue is that a call is also a service and therefore the architecture is service dependent
- INAP messages are independent of voice channel connections

Phase 1 CAMEL architecture

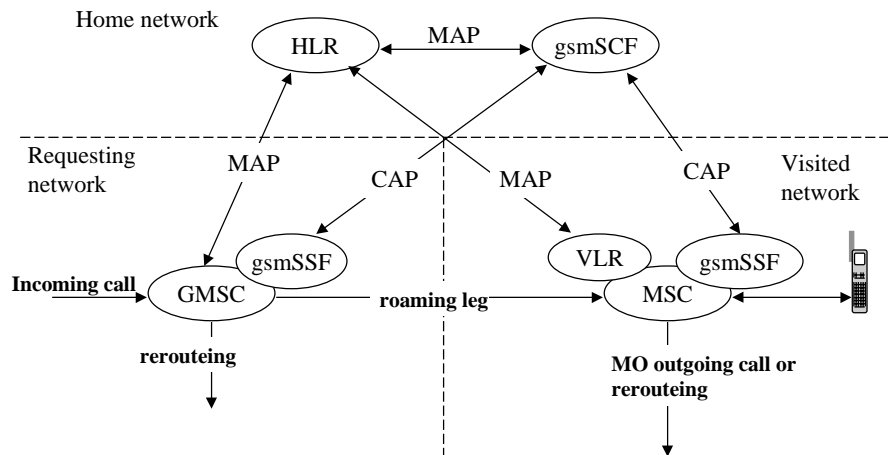

MS originated CAMEL call

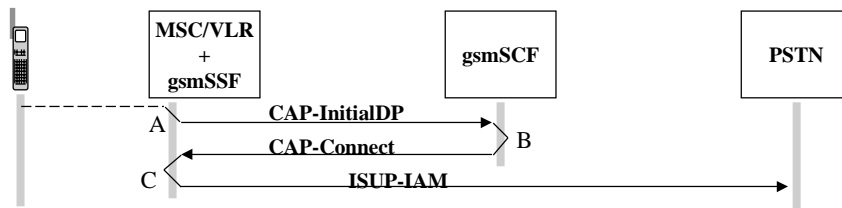

- A - MSC gets the CAMEL service info from the VLR concerning the A subscriber, sees an active CAMEL service and hands the call to gsmSSF. gsmSSF queries gsmSCF:lle (service key, A-nr, B-nr, IMSI, location...
- B - gsmSCF can for example do a number translation
- C - MSC sets up a call using the received info

Mobile terminated CAMEL call

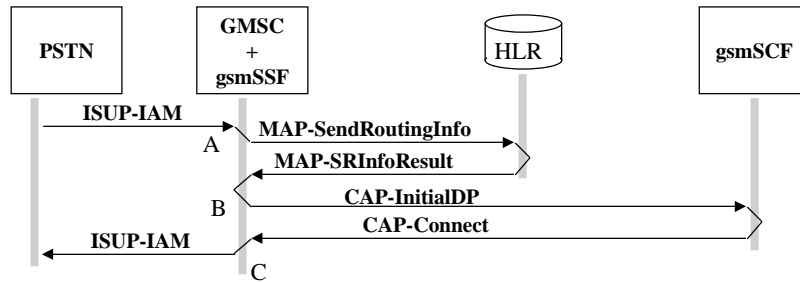

- A - GMSC queries HLR of the location of the MS. HLR sends the terminating CAMEL service data of the subscriber.
- B - GMSC hands the call to gsmSSF, which queries gsmSCF. gsmSCF returns C-number that is used for routing the call.
- C - GMSC sets up the call to C-number. If needed, GMSC can first do a new HLR query.

IN+GSM integration based on CAMEL is a step towards 3G

- CAPv1 supports only 7 operations
- CAPv1 call model has only a few triggering points (TDP - trigger detection point)
- CAPv2 has 22 operations
- Still no triggering for Short Messages
- CAMEL compatible equipment is in use in many networks